

# RESIDENCE LECLERC

## ETAT ACTUEL

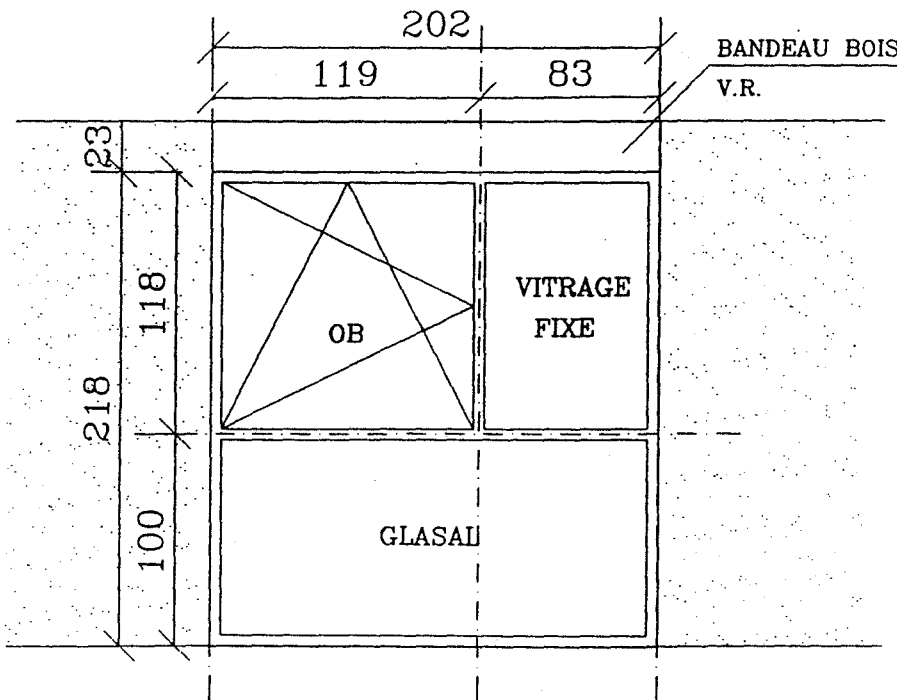
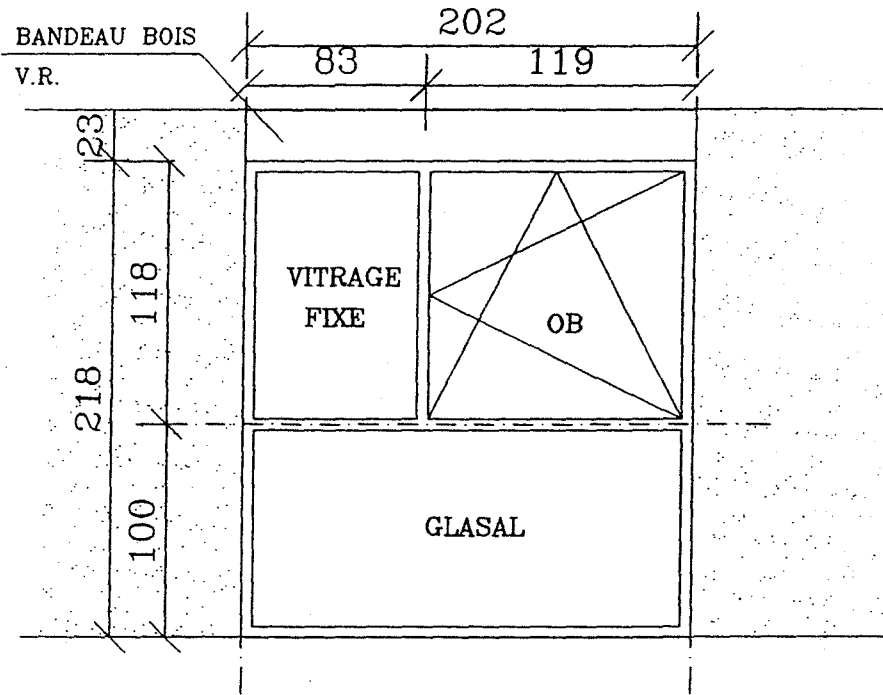

## FACADE COURANTE

# RESIDENCE LECLERC

## ETAT FUTUR RENOVATION (REPERE 1) ( SUR FACADE )

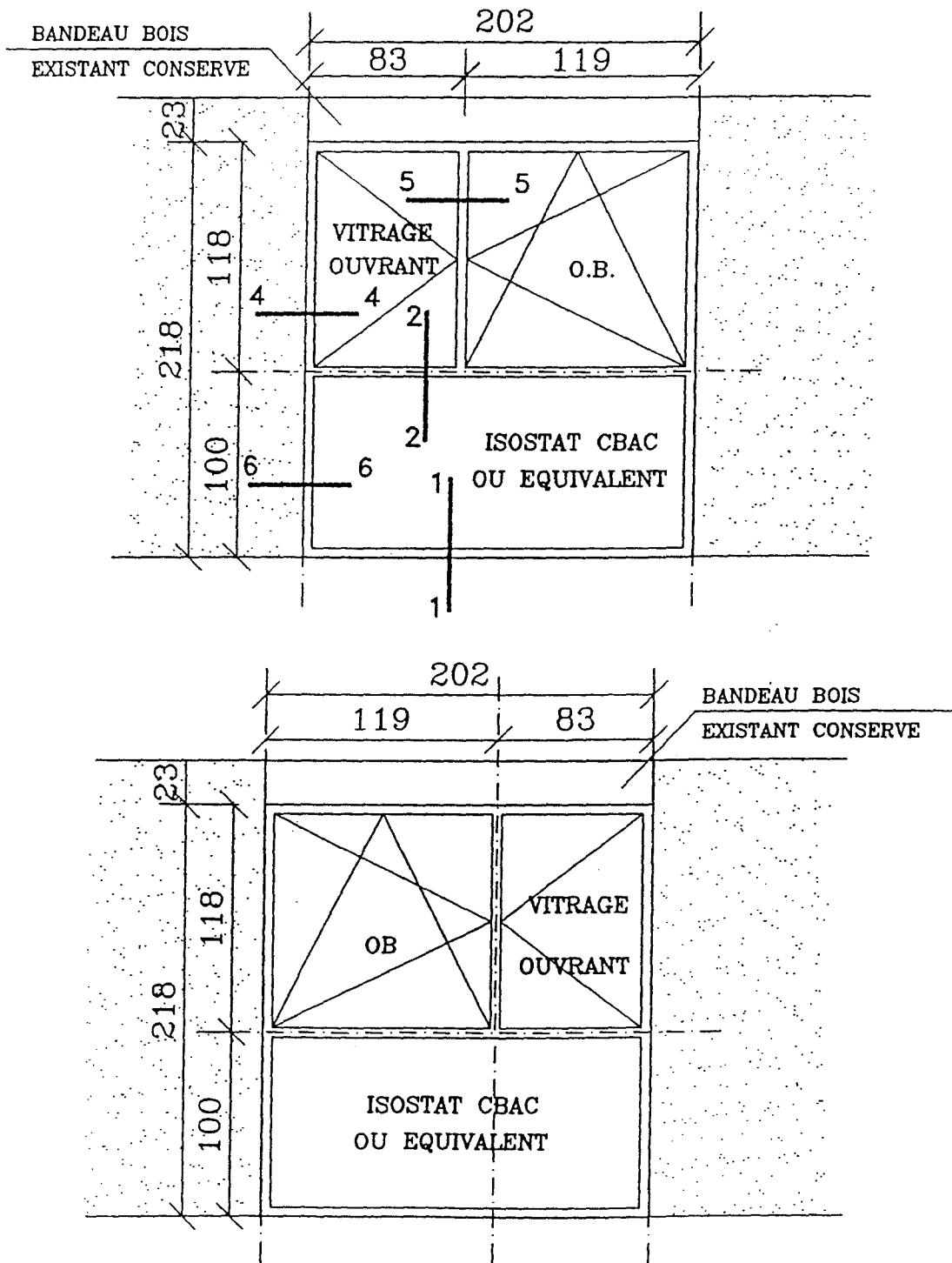

FACADE COURANTE

# RESIDENCE LECLERC

ETAT ACTUEL

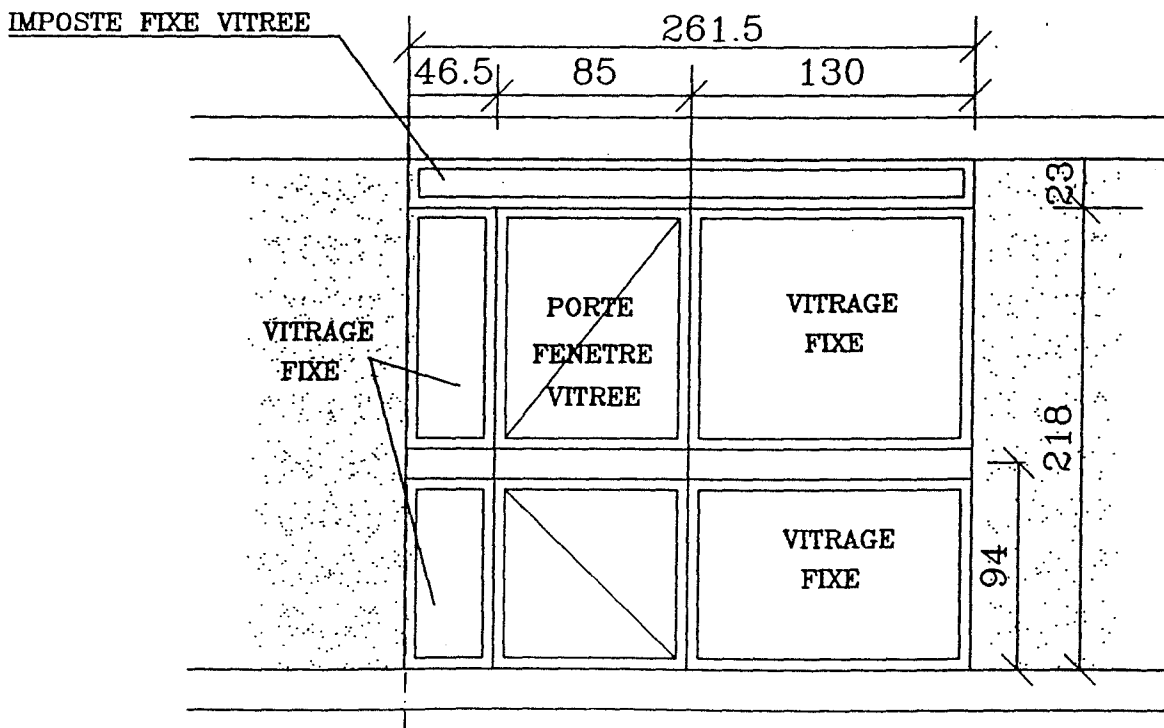
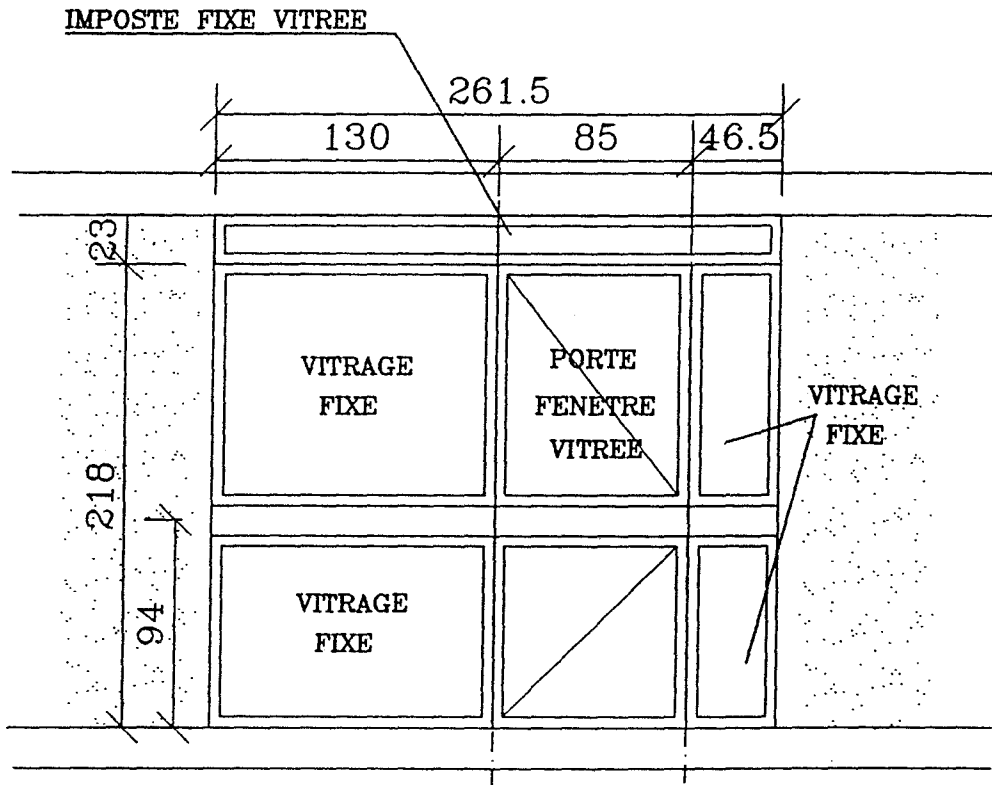

SEJOUR

# RESIDENCE LECLERC

ETAT FUTUR

RENOVATION (REPERE 2)

( SUR BALCON )

PANNEAU ECOSTA EN IMPOSTE OU COFFRE  
DE VOLET ROULANT SUIVANT OPTION

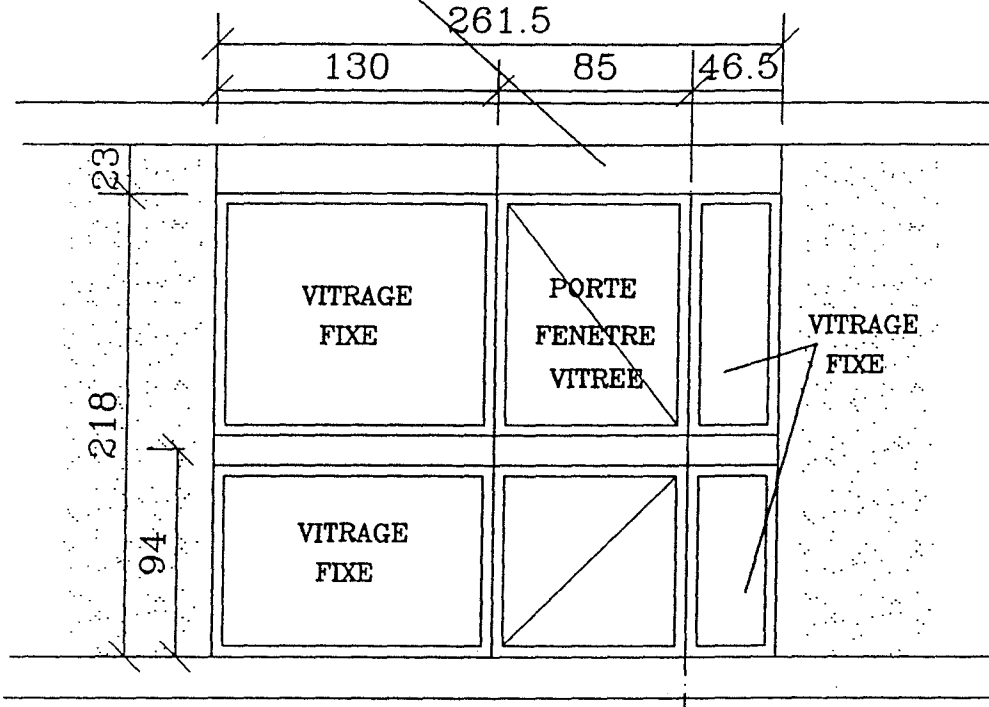

PANNEAU ECOSTA EN IMPOSTE  
OU COFFRE DE VOLET ROULANT  
SUIVANT OPTION

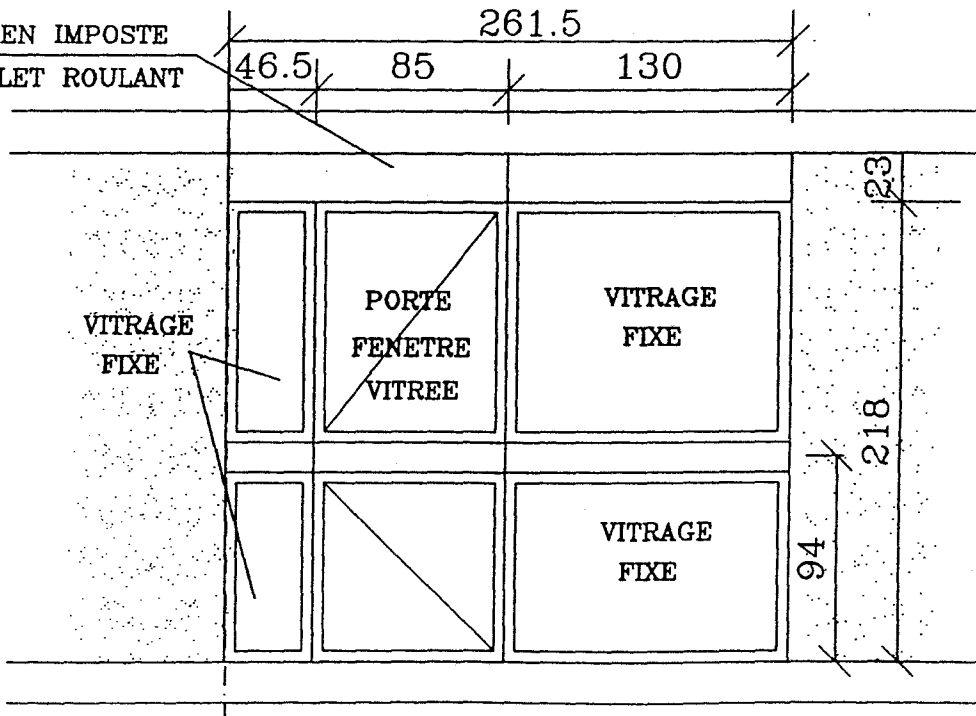

SEJOUR

# RESIDENCE LECLERC

## ETAT ACTUEL

VITRAGE FIXE  
VOLET ROULANT A RDC

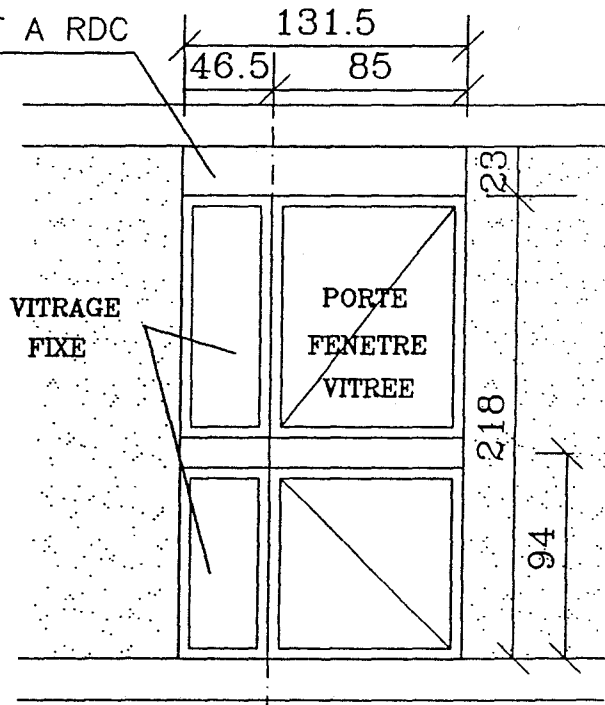

VITRAGE FIXE  
VOLET ROULANT A RDC

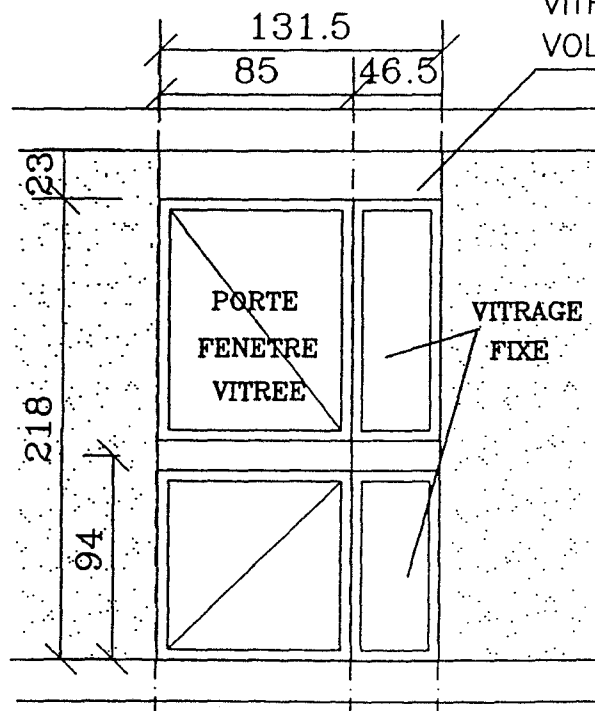

CUISINE

# RESIDENCE LECLERC

ETAT FUTUR

RENOVATION (REPERE 4)

( SUR BALCON )

PANNEAU ECOSTA EN IMPOSTE  
OU COFFRE V.R. SUIVANT OPTION

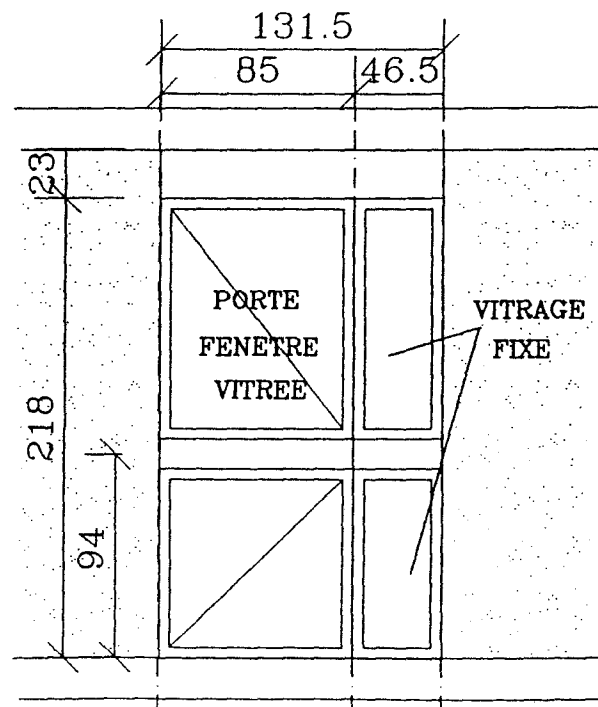
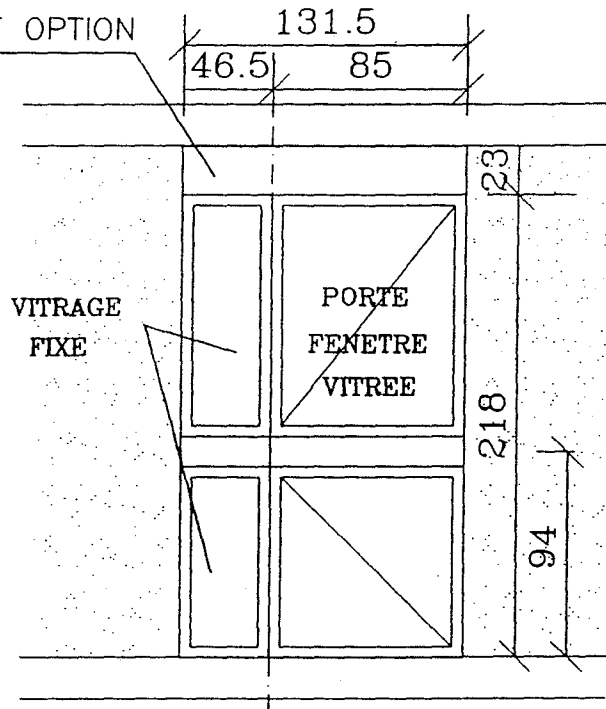

CUISINE

# RESIDENCE LECLERC

## ETAT ACTUEL

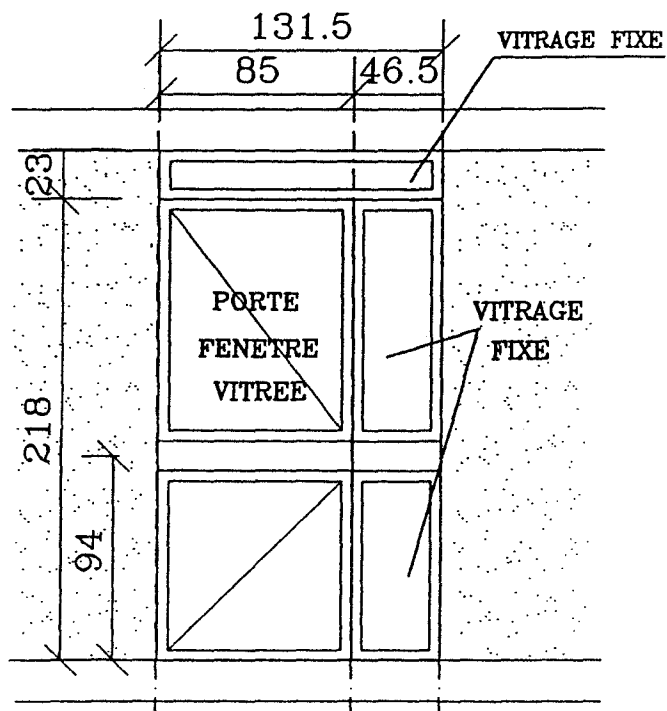
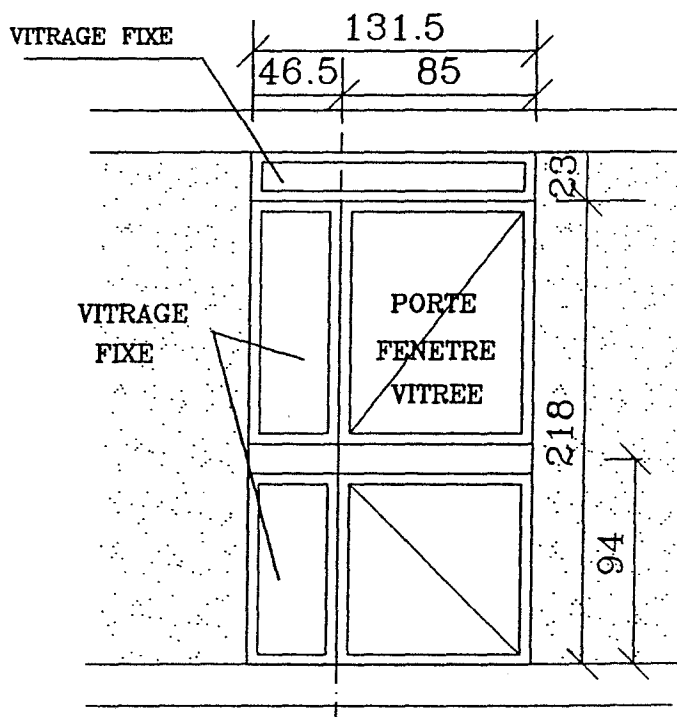

CHAMBRE SUR BALCON

# RESIDENCE LECLERC

ETAT FUTUR

RENOVATION (REPERE 3)

( SUR BALCON )

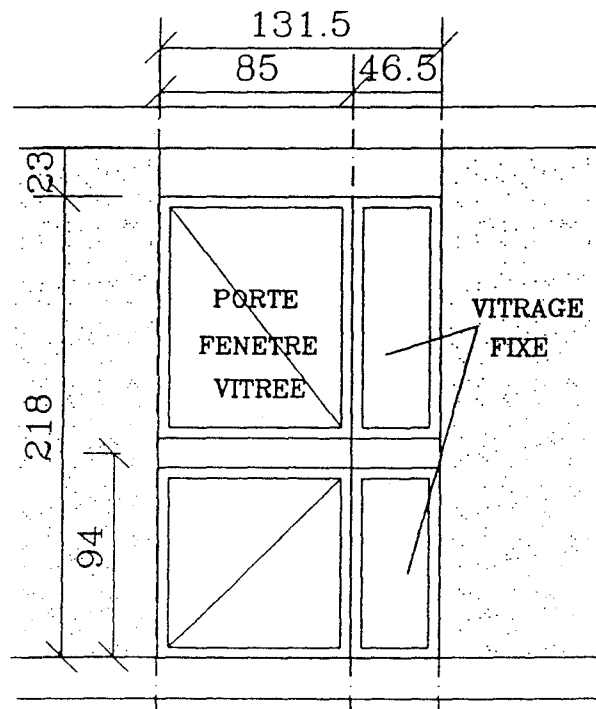
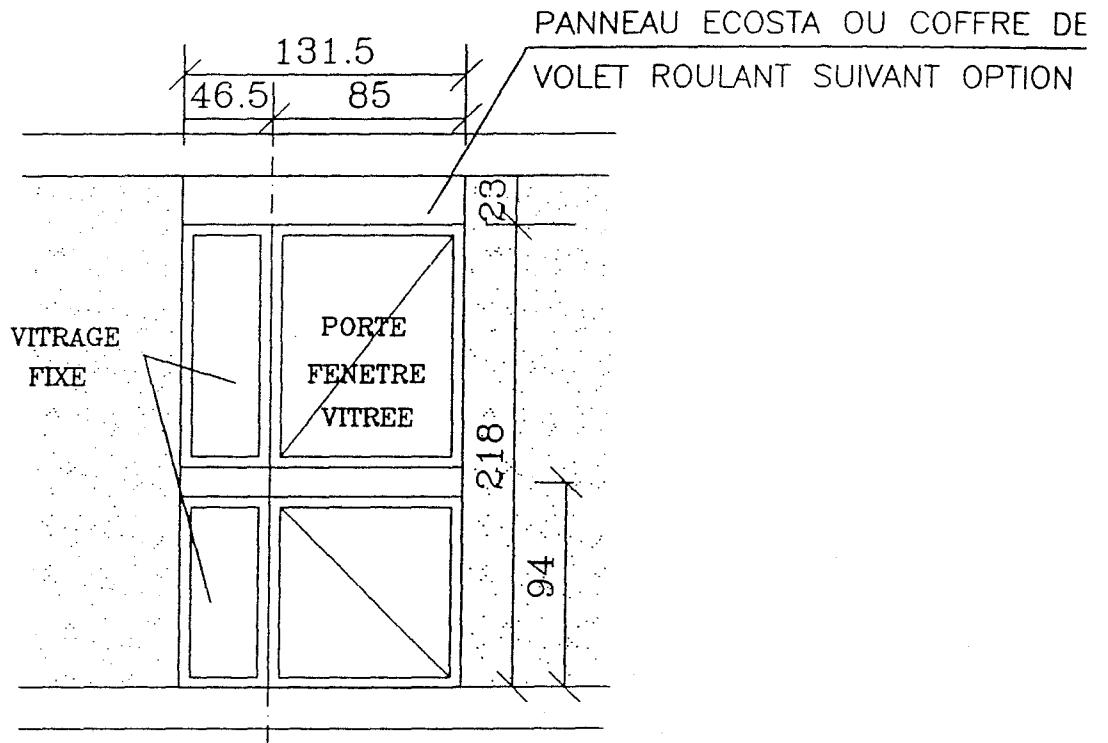

CHAMBRE SUR BALCON



- Ⓐ BORMANT EXISTANT
- Ⓑ FOURRURE
- Ⓒ GALAGE
- Ⓓ JOINT COMPRI ME
- Ⓔ JOINT ETANCHE
- Ⓕ DRAINAGE

